

## Acrylic print holders



## TABLE-TOP SIGNS



**Slim Frame** tabletop sign holders are on P11

### Acrylic print holders

These industry standard acrylic products are fabricated from high clarity material. We offer a range of sizes in slanted (lean-back) and upright styles, together with triangular and slatwall models.



**Triangular holder** 3x 1/3A4



**Slatwall holders** A4 & A5

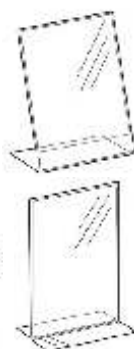
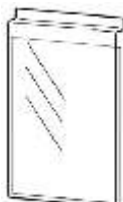

### Acrylic Print Holders slanted and upright

Order Code		£ ea	20 @	50 @
PH.A4	A4 Print Holder (slanted)	3.80	3.42	3.12
PH.A5	A5 Print Holder (slanted)	2.50	2.25	2.05
PH.1/3A4	1/3A4 Print Holder (slanted)	2.20	1.98	1.80
PH.A4U	A4 Print Holder (upright)	5.25	4.73	4.31
PH.A5U	A5 print Holder (upright)	3.30	2.97	2.71
PH.A4U/L	A4 Print Holder (upright) landscape	5.60	5.04	4.59

### Acrylic Print Holders triangular and slatwall

Order Code		£ ea	20 @	50 @
PH.SL.A4	A4 Print Holder for Slatwall	4.99	4.49	4.09
PH.SL.A5	A5 Print Holder for Slatwall	3.50	3.15	2.87
PHT.1/3A4	Triangular 1/3A4 Print Holder	7.99	7.19	6.55

## Tru-Vu card holders

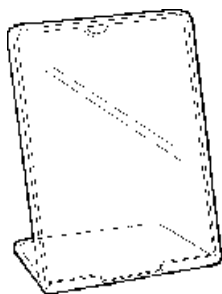

**A4 Tru-Vu**  
Angled card holder  
(CH.A4)

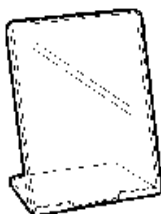

**A5 Tru-Vu**  
Angled card holder  
(CH.A5)

**Tru-Vu angled card holders** have an opening in the top allowing inserts to be slotted into place.

They are closed on 3 sides so prints cannot slip out sideways. They are moulded from high grade clear plastic.

### Tru-Vu Card Holders

Order Code		£ ea	20 @	50 @
CH.A4	A4 Card Holder (angled)	4.65	4.22	3.85
CH.A5	A5 Card Holder (angled)	3.20	2.88	2.62



## Menu Holders

- \* 2-part unit - rigid PVC pocket pushes into base.
- \* 1/3 A4 version can also be used landscape.



### Menu Holders

Order Code		£ ea	20 @	50 @
MH.A4	A4 Menu Holder	4.40	3.96	3.61
MH.A5	A5 Menu Holder	2.80	2.52	2.30
MH.1/3A4	1/3 A4 Menu Holder	2.50	2.25	2.05

## Ivory menu board holder



## Ebony chalkboard / holder



- \* Dual use model - quality chalkboard doubles as an eye-catching print holder.
- \* Generously sized to show a border around your A4 or A5 prints.

- \* Contemporary frosted acrylic design.
- \* Brushed aluminium poster snap top makes it very quick and easy to change your message.

### Ebony and Ivory menu board holders

Order Code		£ ea	10 @	25 @
EB.A4	A4 Ebony chalkboard / holder	8.50	7.65	6.97
EB.A5	A5 Ebony chalkboard / holder	6.95	6.26	5.70
IV.A4	A4 Ivory menu board holder	8.50	7.65	6.97

## Special holders and clips



### Deli-style

- \* Choice of frame size
- \* Tray clip or base

#### Deli-style Klick frames

Standard colour: White

Order Code		£ ea	20 @	50 @
FK.A7/Base	A7 Klick frame with base	2.60	2.34	2.13
FK.A8/Base	A8 Klick frame with base	2.33	2.10	1.91
FK.A7/Tray	A7 Klick frame + tray clip	1.90	1.71	1.56
FK.A8/Tray	A8 Klick frame + tray clip	1.65	1.49	1.35



### Card Grippers

- \* Very versatile design
- \* Adjustable angle

Order Code	Description	£ ea	100 @	300 @
CG.01	Card Gripper with tube clamp	0.85	0.70	0.64
CG.02	Card Gripper with smaller clip	0.50	0.41	0.38

## Klick Boutique



- \* For windows and in-store use
- \* Modular mini-slat system
- \* Easy to update
- \* Card holder option on 400 mm stand

Available as table top model or on 400mm stand with plastic base. Stand can be supplied with a Klick Boutique holder, OR with a simple push-in card holder (as pictured). The head angle is adjustable.



**Klick Boutique** is a mini-slat system 110mm wide by 175mm high. The holder has space for 6 labels, each 25mm deep by 110mm wide. It has a rear support leg. Clear plastic label covers are included - for use with your own paper inserts.

Order Code		£ ea	20 @	50 @
KLB	Klick Boutique with 6 inserts	5.25	4.73	4.31
KLB.400	Klick Boutique with 400 mm stand	10.25	9.59	8.73
KLC.400	Klick Cardholder + 400 mm stand	6.35	5.72	5.21

## Techno A4

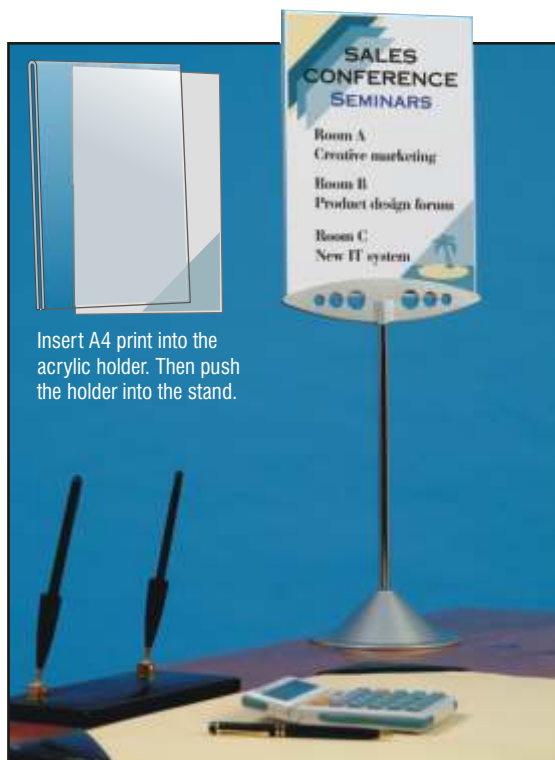

Insert A4 print into the acrylic holder. Then push the holder into the stand.

- \* Contemporary matt silver & chrome design
- \* c/w A4 acrylic print holder (slots into the stand)

Code		£ ea
TECH.A4	Techno A4	19.50

## Card Clips

- \* Free-standing - for small cards
- \* Adhesive version can be used in pairs - for larger header cards

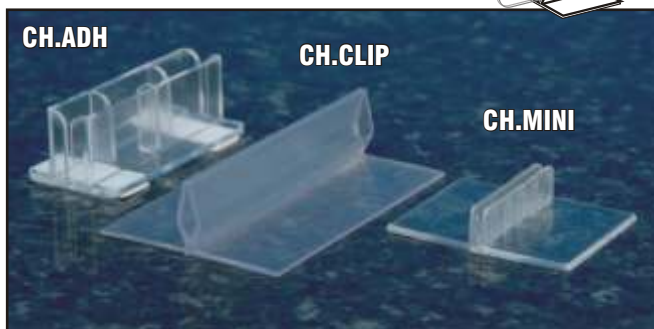

Left to right:

CH.ADH	Adhesive (header) card clip	<i>Width</i> 60 mm
CH.CLIP	Card Clip - extruded PVC	75 mm
CH.MINI	Mini Card Clip	40 mm

**Card Clips** Min. order qty. for card clips is 10 pieces

Order Code	Description	£ ea	10+	100@
CH.ADH	Adhesive Card Clip	0.35	0.30	
CH.CLIP	Card Clip PVC	0.25	0.21	
CH.MINI	Mini Card Clip	0.12	0.10	
CH.MINI/S	Mini Card Clip - slanted	0.12	0.10	

Mini Card Clip

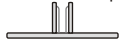

Mini Card Clip - slanted

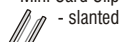

## Desk Presenter



DPA5



DP1/3A4

Acrylic holder locates securely into aluminium base

### Desk Presenter and Menu Card Holder

Order Code		£ ea	25 @	100 @
DPA4	A4 Desk Presenter	14.95	13.46	12.26
DPA5	A5 Desk Presenter	11.10	9.99	9.10
DP1/3A4	1/3 A4 Desk Presenter (DL size)	9.25	8.33	7.59
DPA4X	A4 Desk Presenter plus card holder	18.80	16.92	15.42
MCH	Menu Card Holder	13.90	12.51	11.40

**Desk Presenter** is an elegant clear acrylic sign holder with a designer curved aluminium base. Suitable for prestigious double-sided applications.

**Menu Card Holder** has a weighted base and coil spring to grip menu cards of various sizes.



Menu card holder  
MCH



DPA4X

A4 Desk Presenter with extra holder for business cards etc.

## Dump Bin

This dump bin is an economical wire frame model 400mm (16in) square with adjustable height base.

For maximum impact a sign works wonders. With special clamp fittings (Code DK), which also attach to other types of cage, a Slim Frame can be secured easily and securely. The stem is telescopic.

### Dump Bin and Sign Holder

Sign Holder standard frame colours (see page 10).

Order Code		£ ea	10 @	25 @
DB.400	Dump Bin 400 mm (16 in) sq.	23.00	20.70	18.86
SL.A4/DK	A4 Slim Frame with DK holder	7.99	7.19	6.55



**Left:**  
Wire frame dump bin with A4 sign holder.

DK Clamps secure the sign stem onto wire cages.

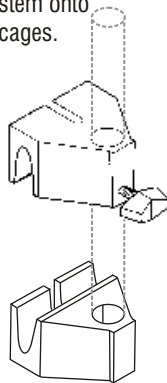

## Banner Hanger

← 250 or 400mm →

**SHELF  
BANNER**



Multi-position magnetic base fixes to shelves or back panels. The arm comes with slide-along banner suspension hooks.



### Magnetic Banner Hanger

Order Code		£ ea	20 @	50 @
MBH.250	Magnetic banner hanger 250mm	6.25	5.63	5.13
MBH.400	Magnetic banner hanger 400mm	6.95	6.26	5.70

**Flip-up barkers** offer an effective and economic way to attach promotional information to any shelf fitted with data strip. Used by the thousand in stores ranging from supermarkets to garden centres.

See opposite for prices.



## Data Strip

### DS.LS39

Data strip to clip onto Tegometall type shelves



**Data Strip is used for displaying shelf-edge labels. It is ideal for EPOS systems and general pricing.** We stock three styles of data strip which suit most situations.

All three are designed for labels up to 39 mm (1½ in) high, with clear fronts and backs in white. We stock in 1 m lengths. Other styles, lengths (and colours) are available, but min. order quantities apply.

**DS.LS39** fits Tegometall and some other popular makes of metal shelf. In many cases it will clip on at a choice of two different angles.

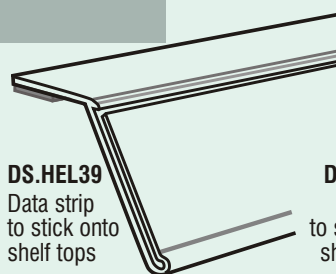

### DS.HEL39

Data strip to stick onto shelf tops

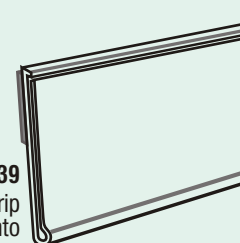

### DS.DBR39

Data strip to stick onto shelf fronts

**DS.HEL39** has a wide top section with self-adhesive strip for fixing onto shelf tops. **DS.DBR39** is for attaching to vertical shelf fronts and racks.

*Samples are available to check fit - please call.*

### Data Strip

Std. Colours: White or clear

For 300+ m please ask for a quotation

Order Code		£ per m	1-39m	40 m	100 m
DS.LS39	Data strip to suit Tegometall	2.80	2.52	2.30	
DS.HEL39	Angled data strip + adhesive tape	2.80	2.52	2.30	
DS.DBR39	Vertical data strip + adhesive tape	1.70	1.53	1.39	



**Klick frames**

**Flip-up Barker**

Fits data strip shelf edging (scanner rail)

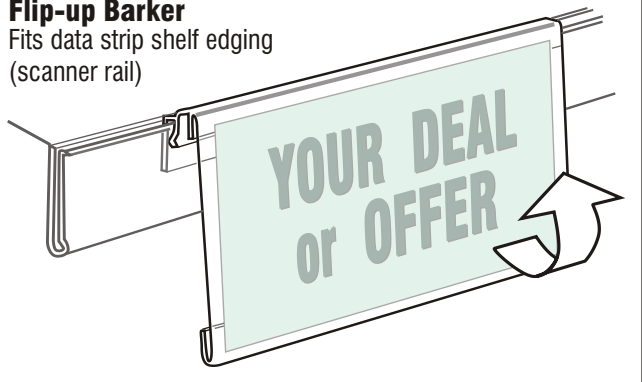

Your POS faces the customers as they walk down the aisle

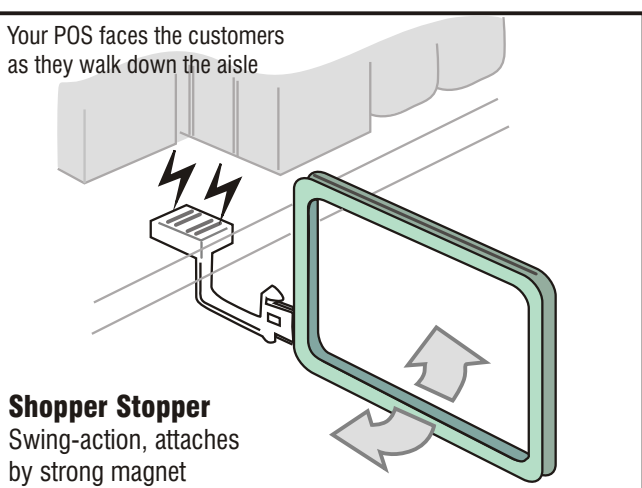

**Shopper Stopper**

Swing-action, attaches by strong magnet

**Shelf edge promotion**

**Klick Frames**

**Klick frames** are effective shelf-edge barkers. Shelf-edge clips simply "click" into the backs of the frames. There are clips for many types of shelving - the most common ones are shown below.

We stock two sizes of Klick frame. Both are ideally suited to in-house sign making: **1/4 A4** allows 4 'tickets' per A4 page **A7** 8 per page.

**Klick frames and Clips**

Colours: Green, Red or Black (other colours to order - may be subject to MOQs)

Order Code		£ ea	50 @	200 @
KLICK.A7	A7 Klick frame (requires 1 clip)	0.85	0.70	0.64
KLICK.QA4	1/4 A4 Klick frame (req. 2 clips)	0.99	0.81	0.74

Order Code		£ ea	100 @
OEK.324	Klick clip for 30 mm ticket rail	0.22	0.18
OEK.303	Klick clip for 40 mm ticket rail	0.22	0.18
OEK.305	Klick clip to fit Tegometall shelves	0.25	0.21

**Code KLICK.A7**  
105 x 74mm  
One clip per frame



**Code KLICK.QA4**  
210 x 74mm  
Two clips per frame

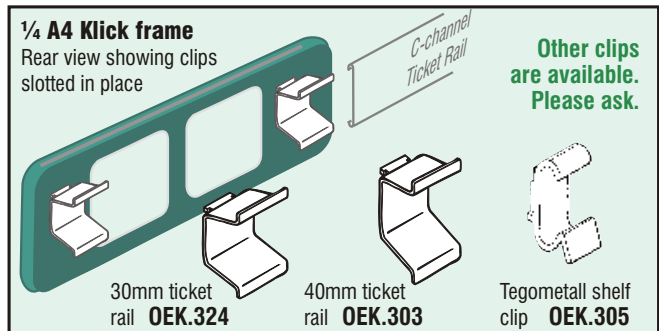
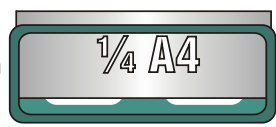

**Flip-up Barker**

For shelving fitted with data strip the Flip-up Barker is ideal. Two sizes are stocked (same as Klick - see above). The clear plastic barker attaches easily to the front of the data strip and is hinged. The hinge means that removal of product from the shelf below is easier and labels or bar codes beneath the barker can be accessed.

Order Code		£ ea	100 @	300 @
FLIPA7	A7 Flip-up barker	0.20	0.16	0.15
FLIP.QA4	1/4 A4 Flip-up barker	0.30	0.25	0.23

**Shopper Stopper**

The frame stands out at 90 deg to the shelf. It is sprung so that when deflected it returns naturally to the correct position. The Shopper Stopper attaches to the underside of the shelf by means of a powerful magnet. Size: A6 (4"x 6" approx.) Colours: Green / Red

Order Code		£ ea	20 @	50 @
SHORST.A6	A6 Shopper Stopper	3.10	2.79	2.54